



ASSEMBLY INSTRUCTION

LE FRANSCHHEOK 6 DRAWER DRESSER WITH MIRROR

ITEM CODE 54391

Imported by Super A-mart Pty Ltd, Qld, Brisbane Australia.

For any assistance with assembly or for missing parts please phone
Super A-mart Ewing Road, Customer Service Free call 1800 351 084

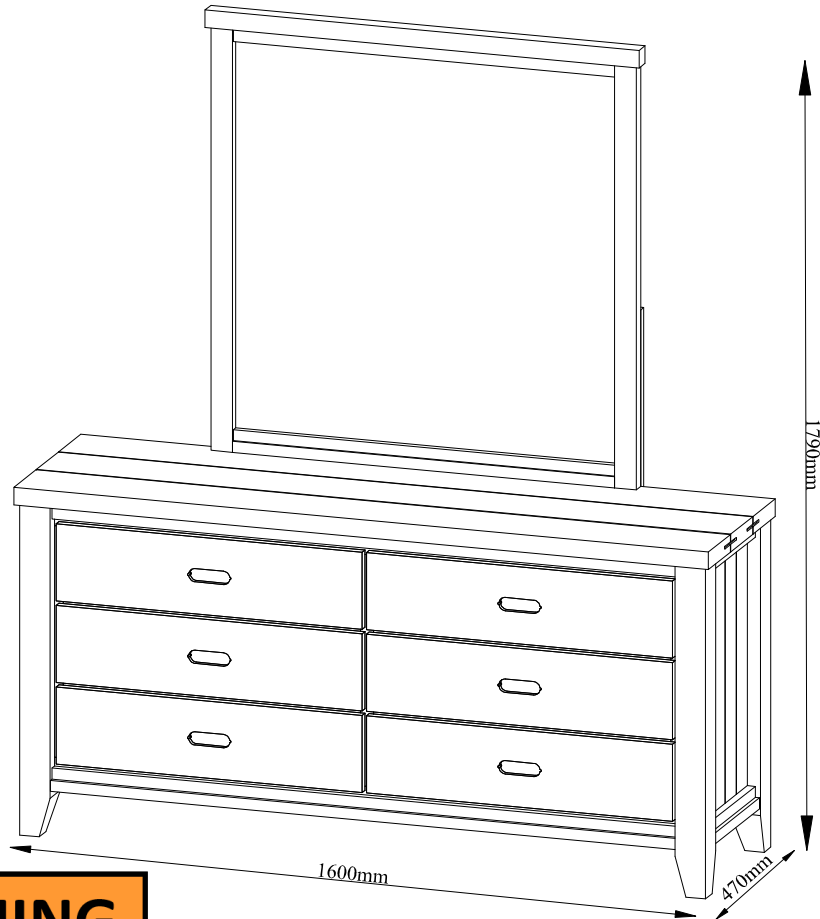

WARNING

Serious or fatal injuries may occur from furniture toppling over.
To help avoid this please follow the below recommendations:

- Install the provided "Tipping Kit" as per the instructions
- Never allow children to climb on or hang off of any part of this product
- Unless specifically designed to accommodate, do not set TVs or other heavy objects on top of this product

If this product has drawers:

- Place the heaviest items in lowest drawers
- Do not open more than 1 drawer at a time as this may cause the product to become unbalanced
- Do not tamper with or remove any drawer interlocking/running system

Note: The use of the provided "Tipping Kit" may reduce but not necessarily eliminate the risk of furniture toppling over.
Please use this product with caution.

This is a permanent label. Do no attempt to remove!

Imported by Super A-mart Pty Ltd, Qld, Brisbane Australia.

For any assistance with assembly or for missing parts please phone
Super A-mart Ewing Road, Customer Service Free call 1800 351 084

PRE-ASSEMBLY PREPARATION

Before you start:

1. Choose a clean, level, spacious assembly area. Avoid hard surfaces that may damage the product
2. Take care when lifting. Product should be assembled as near as possible to the point of use
3. Ensure that you have all required contents for complete assembly
4. Always read the assembly instructions carefully before beginning assembly.
5. Keep all hardware parts and packaging out of reach of small children.
6. Do not over tighten the screws and bolts as this may damage the threads



ALLOW 15 MINUTES





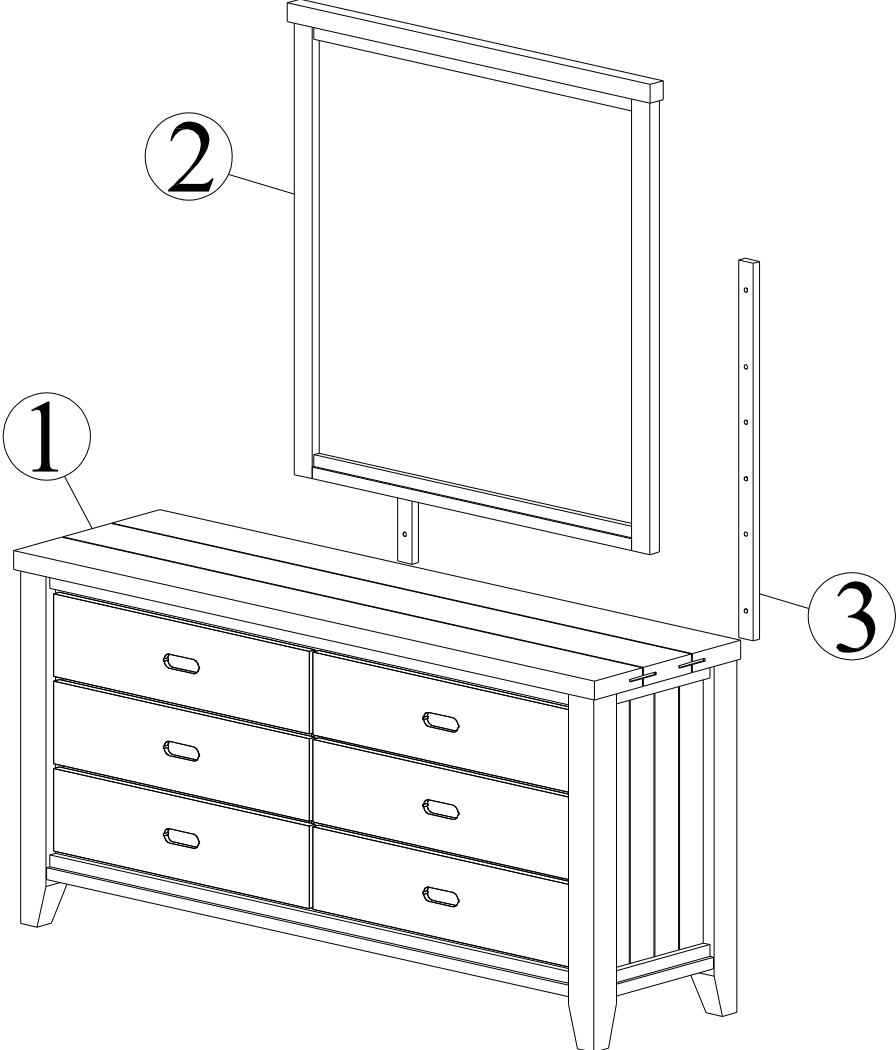

2 PEOPLE REQUIRED

PARTS LIST





1	DRESSER
2	MIRROR
3	SUPPORT BAR

a. Bolt M6x40  12pcs	b. Allen key M4  1pc	c. Flat Washer $\Phi 6.5 \times \Phi 19$  12pcs	d. Lock Washer $\Phi 6.5 \times \Phi 9$  12pcs
---	---	--	---

1

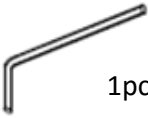

ITEMS REQUIRED

a. Bolt M6x40  6pcs	b. Allen key M4  1pc	c. Flat Washer $\Phi 6.5 \times \Phi 19$  6pcs	d. Lock Washer $\Phi 6.5 \times \Phi 9$  6pcs
--	---	---	--

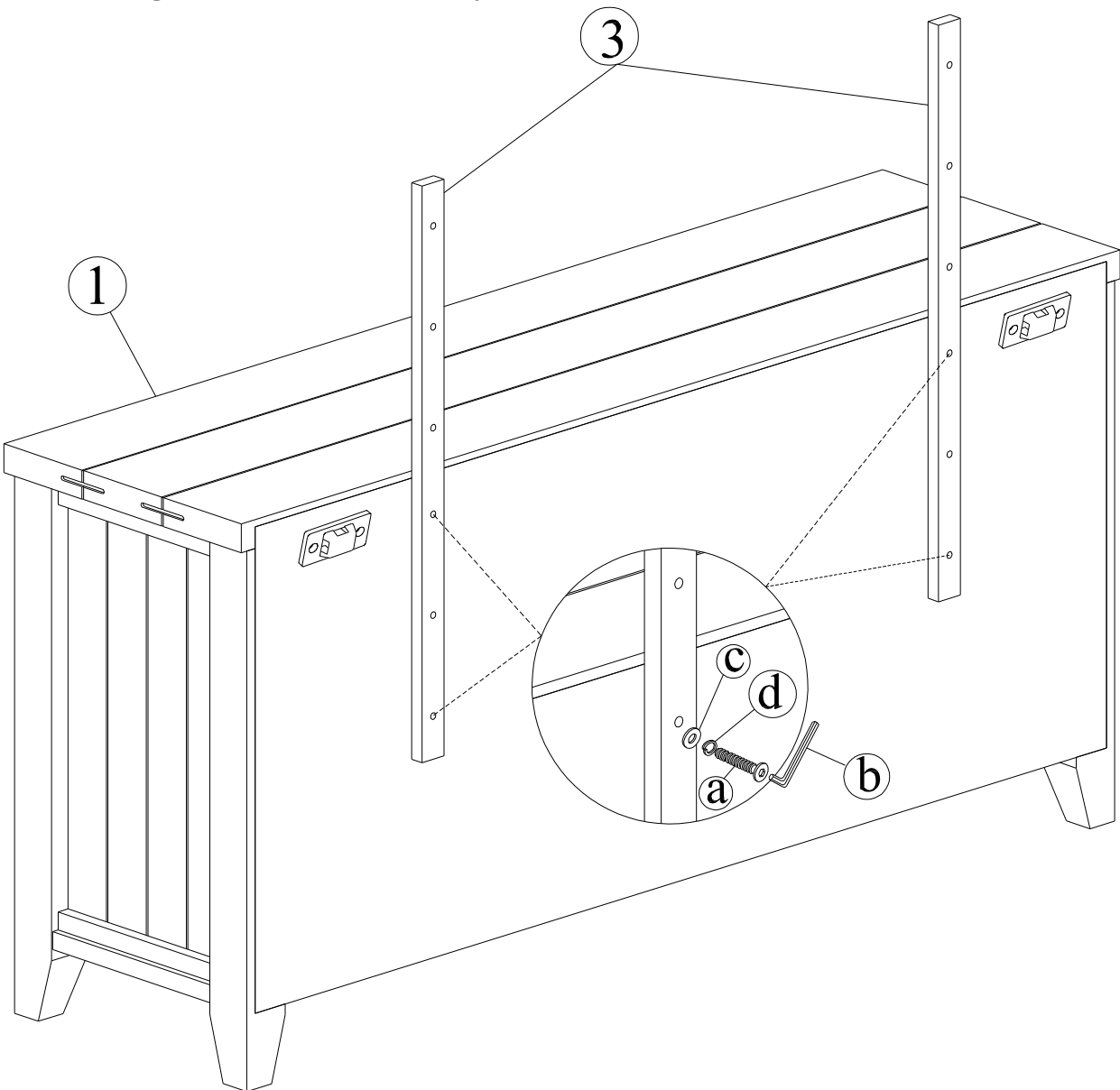
- Attach Support Bar (3) to Dresser (1) using bolts (a) with flat washer (c) and lock washer (d).
- Tighten with Allen Key (b).

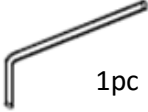

2 ITEMS REQUIRED

b. Bolt M6x40  6pcs	b. Allen key M4  1pc	c. Flat Washer $\Phi 6.5 \times \Phi 19$  6pcs	d. Lock Washer $\Phi 6.5 \times \Phi 9$  6pcs
--	---	---	--

- Attach mirror (2) to Support Bar (3) with bolts (b) and Flat washer (c) and lock washer (d).
- Tighten with Allen Key (b).

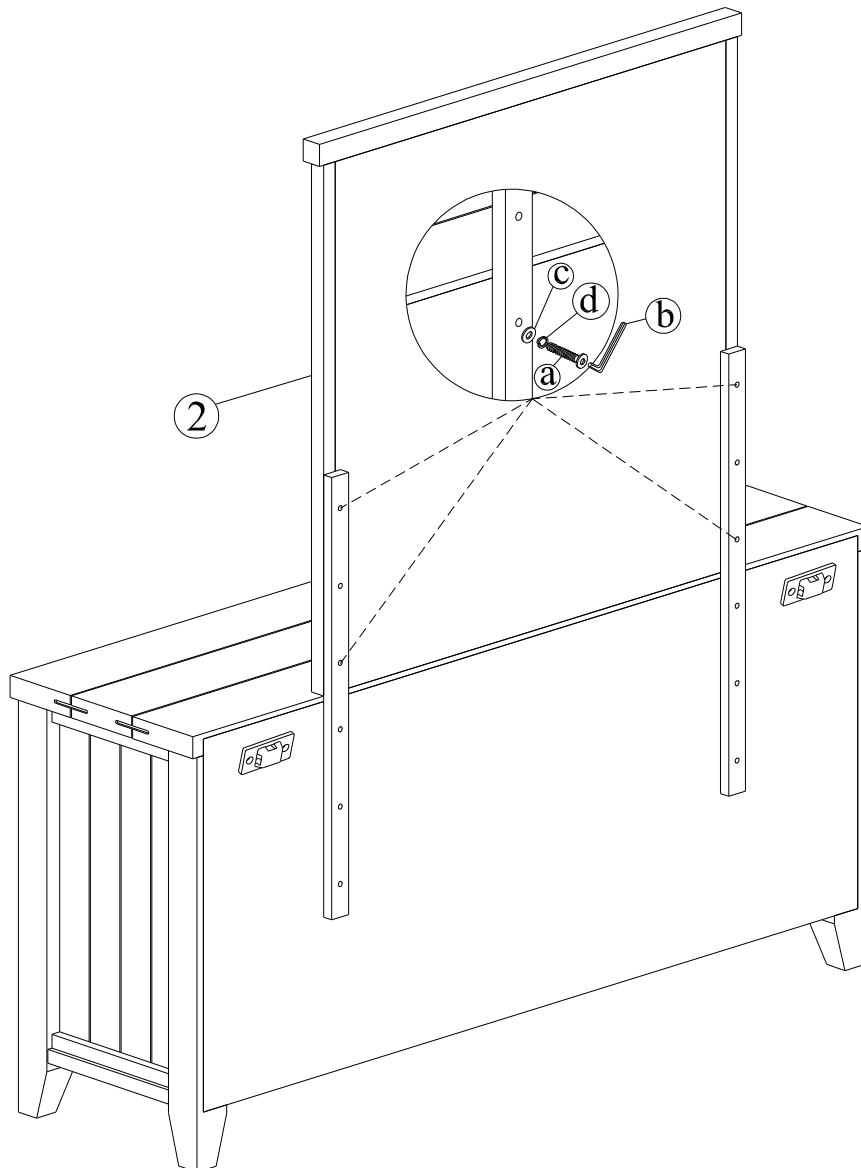



SAFETY BRACKETS INSTRUCTIONS

1. Attach one bracket to the wall, with the long screws as shown. Make sure to attach the bracket into a stud. If mounting onto brick or masonry, you will need to acquire wall anchors.
2. Attach a bracket to the furniture frame under the top with the short screws provided.
3. Move the furniture into its final position. Thread a strap through the bracket as shown in the illustration, tighten strap until snug. Do not over tighten.
4. Make sure the bracket is firmly attached to the wallboard and furniture, and the strap is snug.

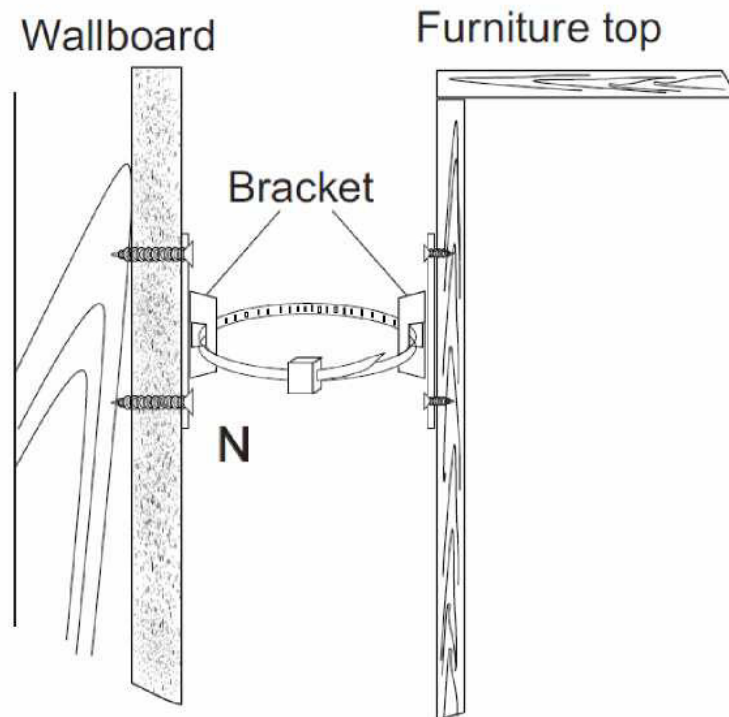

ASSEMBLY IS COMPLETE





Care label for timber items

- A multi-step finish is applied to all our furniture, but all wood comes from nature. Because of this, there will be natural variations in surface texture and grain like knots, mineral streaks and sap runs that may affect the finish. These differences in character are not defects, but distinctions that make each piece of furniture unique.
- Our furniture is built to last. Following these steps for basic care should protect your investment for years to come.
- Dust frequently with a clean damp lint-free cloth. This will help remove abrasive build up which can damage a finish over time.
- Do not place hot objects on any furniture surface. Always use a hot plate or placemat. Laminate and lacquer finishes on table tops provide added scratch and heat resistance to our furniture, but they can still be damaged without proper care.
- Avoid exposing your furniture to strong sunlight, heat outlet, open windows or dampness. Prolonged exposure to direct sunlight can fade the finish of your furniture, while extreme temperature and humidity changes can cause cracking or splitting.
- Do not expose your furniture to any liquids. Never allow water to sit on your furniture. Alcohol, nail polish and perfume are also dangerous as they will dissolve the lacquer finish on contact and may require professional repairs.
- Do not allow plastic to come in direct contact with your furniture. Chemicals in the plastic of placemats etc may soften and mark the finish if left in contact with the furniture for a period of time.
- If the glass is chipped or broken, stop using the product and consult the place of purchase
- Do not drop, drag or strike glass
- Do not sit or stand upon the glass surfaces
- Do not place very hot or cold items on the glass unless adequately thick table mats are used to prevent such items coming in contact with the glass
- Do not place heavy objects on glass
- Avoid scratching the glass or using as a chopping surface
- Do not strike the glass with hard or pointed items
- When cleaning the glass panels, use a damp cloth with washing up liquid or soft soap if necessary. Do not use washing powders or any other substances containing abrasives that may potentially scratch the glass